

QUICKSTART

mōviMS

This quickstart guide is designed for a first time user. Please refer to the full user guide for more detailed information.

A. CHARGE & INSTALL BATTERY



1. Read battery / charging safety info (refer to full user guide).

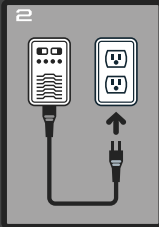

2. Plug Freely charger into wall.

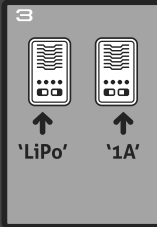

3. Set charger to "LiPo" and "1A" settings.

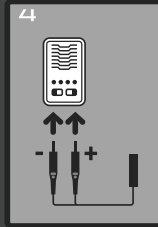

4. Connect charge leads to charger.

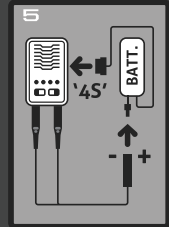

5. Connect battery balance lead to charger.

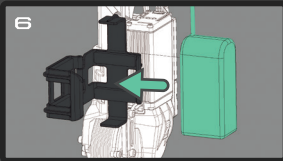

6. Install battery into MōVI (3 steps).

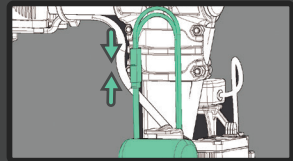
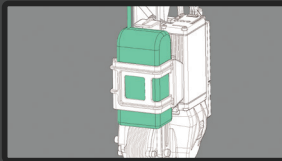

B. INSTALL & BALANCE CAMERA

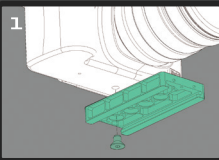

1. Mount fully built camera to bottom camera rail.

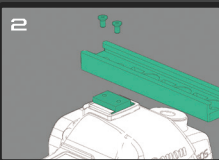

2. Mount top camera rail.

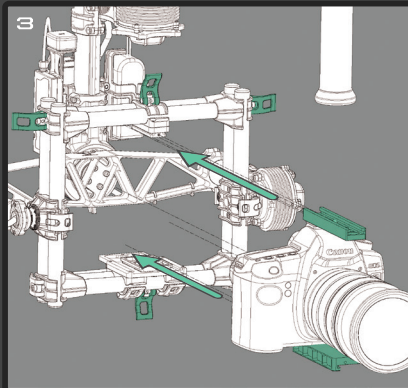

3. Mount camera to MōVI.

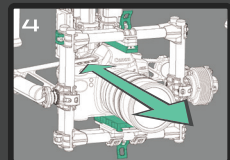

4. Balance tilt axis fore / aft CG.

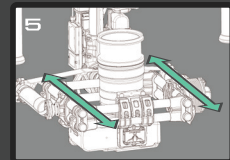

5. Balance tilt vertical CG.

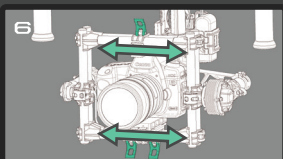

6. Balance roll axis CG.

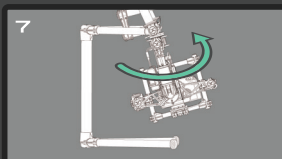

7. Check balance for pan axis CG.

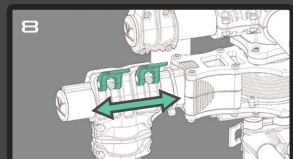

8. Balance pan axis CG.

C. TUNING

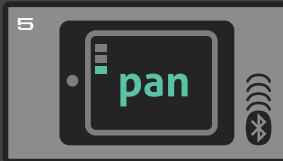
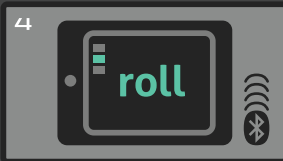
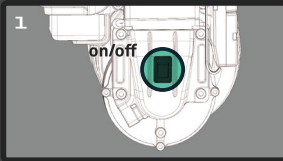

4. Set roll stiffness (under 'roll' tab of the GUI). Set the stiffness as high as possible.

5. Set pan stiffness (under 'pan' tab of the GUI). Set the stiffness as high as possible.

* DO NOT RELY ON THE SETTINGS OUT OF THE BOX TO ACHIEVE BEST RESULTS. FOR BEST PERFORMANCE IT IS IMPERATIVE THAT YOU SET THE STIFFNESS SETTINGS AS HIGH AS POSSIBLE.

D. REMOTE CONTROL (if purchased in package)

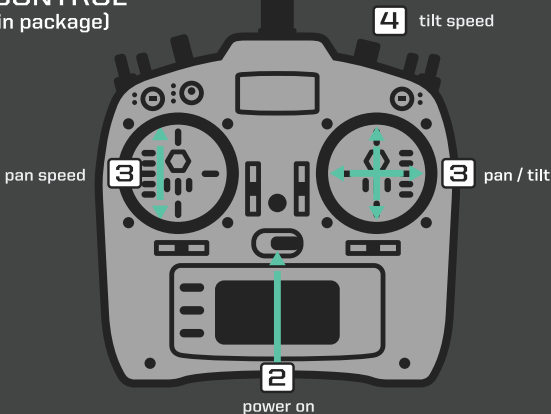

1. Load remote preset from Freefly website (if you purchase transmitter separately).
2. Power transmitter on.
3. Adjust pan speed to user preference.
4. Adjust tilt speed to user preference.